

Installation and Maintenance Manual

IM 1237-3

Group: **WSHP**
 Part Number: **910367776**
 Date: **October 2021**

Digitally Adjustable Display Sensor

Used with:

Water Source Heat Pumps (WSHP) - Sensor Part No. 910152147
 SmartSource® Units - Models GS & GT
 Enfinity™ Units with MicroTech® III Controls - Models CCH, CCW;
 VFC, VFW; LVC, LVW; MHC, MHW & VHC, VHF



Contents

Overview	2	Adjusting the setpoint	6
Sensor buttons & dimensions	2	Occupied icon indicator	7
Applications	3	“OVERRIDE” on the display	7
Sensor functions	3	“ALARM” on the display	7
Mounting, Maintenance, Terminations	4	“E-SAVE” word on the display	7
Mounting	4	“SETPOINT” word on the display	7
Maintenance	4	“STATUS” word & dot on the display	7
Terminations	4	Front panel button operation	7
Initial Start-up, Display Descriptions	6	Optional Technician Adjustments	8
Terminal descriptions	6	Diagnostics	10
Initial start-up occupied sequence	6	Specifications	11
Display descriptions	6		

The display sensor is used in conjunction with the MicroTech III equipped units as described in the Application Section below. The sensor has a digital display for Temperature, Occupancy,

Alarm, Setpoint and Status indication. Controls include four buttons for Setpoint, Occupied/Unoccupied Request, and Over-ride Reset. (Figure 1).

Sensor buttons & dimensions

Figure 1: Digital display sensor - Water Source Heat Pump P/N 9101252147

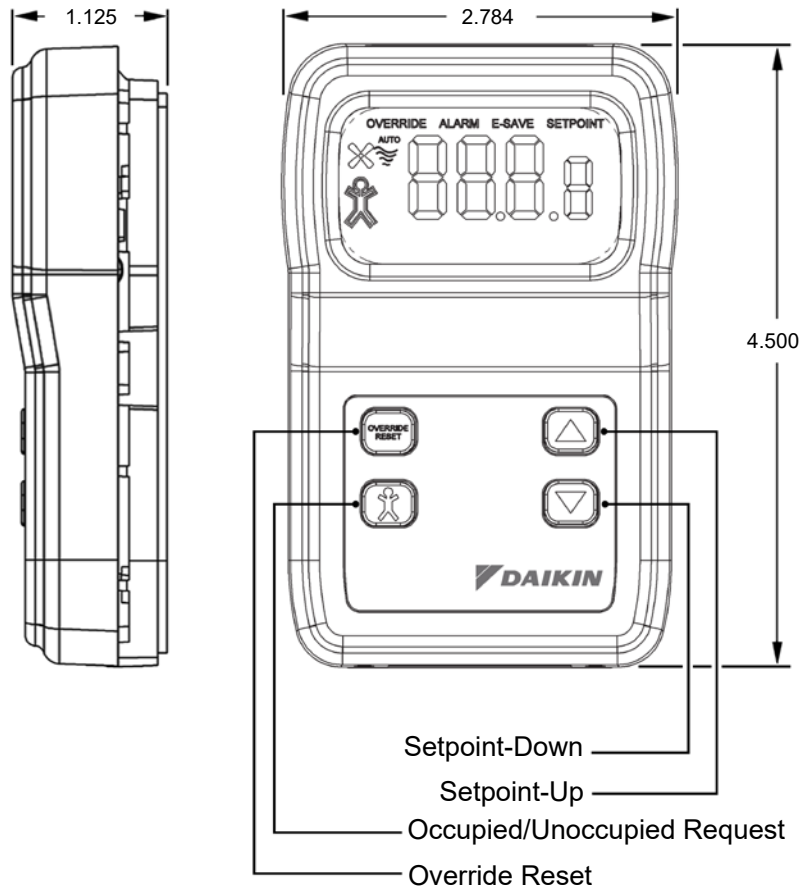

The display sensor can be used on the products shown in [Table 1](#).

Table 1: Product usage guide

Units	Product		Models	Controls	Used with Digitally Adjustable Sensor with Temperature and Humidity Display
Water Source Heat Pumps	Horizontal	Enfinity™	W.CCH, CCW	MicroTech III Unit Controller	Yes
	Vertical		W.VFC, VFW		
	Vertical Stacked		W.VHC		
	Console		W.MHC, MHW		
	Horizontal & Vertical	SmartSource 1-Stage	W.GSH, GSV	MicroTech III SmartSource Unit Controller	
		SmartSource 2-Stage	W. GTH, GTV		

The display sensor for water source heat pump applications is shown in [Table 2](#).

Table 2: Water source heat pump application guide

Units	Product		Models	Applications					
				Cooling	Heating	Electric Heat			Waterside Economizer
				Stages		Boilerless	Supplemental	Primary	3-Way Valve Control
Water Source Heat Pumps	Horizontal	Enfinity	W.CCH, W.CCW	1	1	No	No	No	No
	Vertical		W.VFC, W.VFW	1	1	Yes ¹	Yes ¹	No	No
	Vertical Stacked		W.VHC	1	1	No	No	No	No
	Console		W.MHC, W.MHW	1	1	Yes ¹	Yes ¹	No	No
	Horizontal & Vertical	Smart-Source 1-Stage	W.GSH, W.GSV	3	4	Yes	Yes	Yes	Yes
	Horizontal & Vertical	Smart-Source 2-Stage	W.GTH, W.GTV	3	4	Yes	Yes	Yes	Yes

Note: ¹With optional Boilerless controls

Sensor functions

910152147, Water source heat pump model:

- Display sensor to show room Temperature, ALARM, Override and occupancy.

Mounting

Location

Avoid mounting on outside walls or in direct sunlight.

Junction Box, (J-Box)

1. Pull the wire through the wall and out of the junction box, leaving about six inches free.
2. Pull the wire through the hole in the base plate.
3. Secure the back plate to the box using the #6-32 × 1/2 inch mounting screws provided.
4. Screw the plate firmly to the wall so the foam plate backing is compressed about 50%.
5. Terminate the unit according to the guidelines in the Termination section.
6. Attach Cover by latching it to the top of the base, rotating it down and snapping into place.
7. Secure the cover by backing out the lock-down screws using a 1/16" Allen wrench until it is flush with the bottom of the cover.

Figure 2: Junction box mounting (hardware is provided for both junction box and drywall installation.)

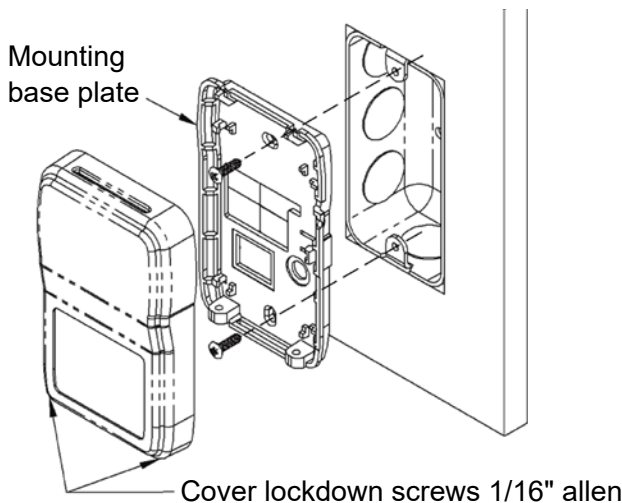

Drywall mounting

1. Place the base plate against the wall where you want to mount the sensor.
2. Mark out the two mounting holes where the unit will be attached to the wall. Drill a 3/16" hole in the center of each mounting hole and insert a drywall anchor into the holes.
3. Drill one 1/2" hole in the middle of the marked wiring through hole area.
4. Pull the wire through the wall and out the 1/2" hole, leaving about six inches free.
5. Pull the wire through the hole in the base plate.
6. Secure the base to the drywall anchors using the #6 × 1" mounting screws provided.
7. Screw the plate firmly to the wall so the foam plate backing is compressed about 50%.

8. Terminate the unit according to the guidelines in the Termination section.
9. Attach cover by latching it to the top of the base, rotating it down and snapping it into place.
10. Secure the cover by backing out the lock-down screws using a 1/16" Allen wrench until it is flush with the sides of the cover

Note: in any wall-mount application, the wall temperature and the temperature of the air within the wall cavity can cause erroneous readings.

The mixing of room air and air from within the wall cavity can lead to condensation, erroneous readings and sensor failure. To prevent these conditions, Daikin recommends sealing the conduit leading to the junction box with fiberglass.

Maintenance

Wipe the display as needed with a damp water only cotton cloth. Do not use any type of cleaner as it may damage the buttons or scratch the display. Do not paint.

Terminations

Daikin recommends using a twisted shielded pair of at least 22AWG for the power wire connections. The shield should be earth grounded only at the power source. Larger gauge wire may be required for long runs.

Figure 3: Sensor Circuit Board

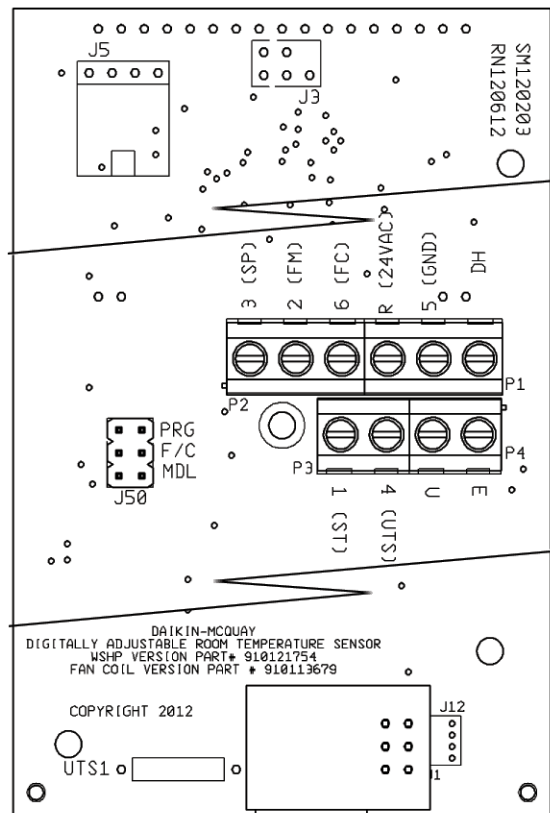

 CAUTION
Combination of power wiring (R, 5) and analog (1, 2, 3, 4) wiring in a common cable may cause signal interference and must be avoided.

All wiring must comply with the National Electric Code (NEC) and local codes. Do NOT run any of this device's wiring in the same conduit as other AC power wiring. Tests show that fluctuating and inaccurate signal levels are possible when AC power wiring is present in the same conduit as the signal lines. If you are experiencing any of these difficulties, please contact your Daikin representative.

Figure 4: SmartSource MicroTech III board to digital room temperature sensor wiring

SmartSource Board	MicroTech III Board					
	Base Board					
Terminal Block Label	TB2-1	TB1-1	TB1-3	TB1-4	TB1-5	TB3-2
Description	24VAC	Unit Status Output	Setpoint Adjust	Room Temp Sensor & Tenant Override	DC Signal Common	Unoccupied Input
Terminal Label	R	1	3	4	5	U
Typical Wiring	↕	↕	↕	↕	↕	↕
Terminal Label	R (24VAC)	1 (ST)	3 (SP)	4 (UTS)	5 (GND)	U
Description	24VAC	Unit Status Output	Setpoint Adjust	Room Temp Sensor & Tenant Override	DC Signal Common	Unoccupied
Sensor	Digitally Adjustable Room Temperature Sensor (Part No. 910152147)					

Terminal descriptions

Note: Refer to "Figure 3: Sensor Circuit Board" on page 4 for terminal locations

- R**..... 15 to 28VAC* (AC requires separate shielded wire) (Shield terminated at power source only)
- U**..... Unoccupied Contact. (Terminal grounded when in Unoccupied, VDC only).
- 1**..... Status Indicator Input from the MicoTech III Unit Controller. (5VDC).
- 3**..... Output Signal, Setpoint Adjust from 55° to 95° F (default) or ±5° Configurable. (0 to 5VDC) See Setpoint Analog Range Tolerances. See Table 3.
- 4**..... Output Signal, Room Temp Thermistor Sensor. (10K ATP Z curve, 10K-2). 910113575 tenant override only
- 5**..... Ground or Neutral* (AC requires separate shielded wire). Common Reference for All Signal Terminals.

Note: * The AC power wiring at terminals [R] & [5] should be run in a separate twisted shielded pair to avoid possible fluctuating and inaccurate signal levels induced into the other sensor signal wires.

This sensor AC power can be run in the same conduit with the sensor signal wire as long as it's run in twisted, shielded pair and terminated properly.

Setpoint analog range tolerance

Table 3: Setpoint analog range tolerance

Setpoint Analog Tolerance			
55° to 95°F Scale	-3° to +3°F Scale	-5° to +5°F Scale	Terminal 3 Analog Output
@ 55°F (min.)	@-3°F (min.)	@ -5°F (min.)	0.0 to 0.10 vdc
@65°F	@-1.5°F	@-2.5°F	1.3 to 1.42 vdc
@75°F	@0°F	@0°F	2.12 to 2.2 vdc
@85°F	@+1.5°F	@+2.5°F	2.58 to 2.63 vdc
@95°F (max.)	@+3°F (max.)	@+5°F (max.)	3.0 to 4.0 vdc

Initial start-up occupied sequence

On initial installation power-up, the sensor is in "Occupied" mode with a solid occupied icon and DC voltage at terminal "U". If the "STATUS/Dot" input on Terminal 1 from the controller indicates occupied ("ON" continuous), then the unit continues to stay "Occupied". If the "STATUS/Dot" input on Terminal 1 from the controller indicates unoccupied (5 seconds "ON" then 5.5 seconds "OFF"), then the occupied icon will flash the desired occupancy state every 8 seconds, indicating to the user a mismatch of the desired occupied status and system occupied status at the controller

Power fail start-up occupied sequence

On a power failure, the sensor retains its last known desired occupancy status in non-volatile memory. On restoration of power, the sensor restores its last known desired occupancy state from memory. The occupied icon will reflect this with a solid (occupied) or hollow (unoccupied) indication and terminal "U" will have voltage applied (occupied) or grounded (unoccupied). If the "STATUS/Dot" input on Terminal 1 from the controller matches this occupancy state then the occupied status icon will continue to be solid or hollow depending on the last known state. If the "STATUS/Dot" input on Terminal 1 from the controller is different from the sensor occupied state, then the occupied icon will flash the desired occupancy state every 8 seconds indicating to the user a mismatch of the desired occupied status and system occupied status at the controller.

Display descriptions

Numerical display



The factory setting default numerical display (Figure 5) shows current temperature (°F or °C) and toggles the setpoint display every 5 seconds.

Figure 5: Sensor numerical display



Adjusting the setpoint

(Temperature)

- Push the  or  button, the displayed setpoint can be adjusted up or down.
- After an adjustment, the setpoint is displayed for 5 seconds.

The unit can also be programmed in the field to "Setpoint Only" display or Setpoint Lockout. See the "Optional technician adjustments" on page 8.

Occupied icon indicator

The Occupied Icon on the left side of the display indicates whether the room sensor is in the Occupied or Unoccupied Mode, (Figure 6).

Figure 6: Occupied & unoccupied icons



Solid is Occupied and Hollow is Unoccupied.

- A blinking icon every 8 seconds indicates an override request that has not been fulfilled.

“OVERRIDE” on the display

The “OVERRIDE” word indicator in the top left corner illuminates when the sensor is signalled by the “Status” input (Terminal 1).

This is initiated from the Override/Reset Button at first and then confirmed from the “Status” input code which keeps the “OVERRIDE” indicator on.

“ALARM” on the display

The “ALARM” word indicator on top illuminates when the sensor interprets the “Status” input code from the controller as an alarm. See Table 4 on page 7.

“E-SAVE” word on the display

The “E-SAVE” word indicator on top illuminates when the sensor interprets the “Status” input code from the controller as Standby Mode (See Table 4 on page 7).

“SETPOINT” word on the display

The “Setpoint” word on top illuminates when the sensor is displaying the setpoint on the numerical display (Temperature). When this “Setpoint” indicator is off, the numerical display shows the actual room temperature.

“STATUS” word & dot on the display

 The Status “Dot” on the display indicates the unit status or alarm condition. It is turned “On” and “Off” by interpreting the status input from the controller on terminal 1.

Table 4 shows the alternating conditions and sensor status.

Table 4: WSHP unit status input timing definition

Status Dot "ON" (+ 5 vdc) time	Status Dot "OFF" (0 vdc) Time	WSHP Availability	Display Indication
0.5 seconds	0.5 seconds	Controller Off (or Network "Wink" operation active)	"ALARM" On
0.0 seconds	Continuous	Unit running in Night Setback Override Mode or no power to the unit	"OVERRIDE" On
0.5 seconds	5.5 seconds	Unoccupied Mode	Hollow Occupied Icon
5.5 seconds	0.5 seconds	Standby Mode	"E-SAVE" On
Continuous	0.0 seconds	Occupied Mode	Solid Occupied Icon

Front panel button operation

Override/Reset button (timed override & alarm reset)

When the “Override/Reset” Button is pressed, the thermistor sensor is shorted. If held for more than 3 seconds but less than 11 seconds, it puts the controller into a timed Occupied Override (the time is set by the controller). If the unit is in alarm, then holding the “Override/Reset” Button for more than 11 seconds will clear all alarms in the controller but only if the cause of the alarm has already returned to its non-alarm condition. Some alarms will not reset from the digital room sensor.

In this case, power to the unit must be cycled off for 5 seconds to clear the alarm. Continuously resetting alarms from the room sensor could damage the controller. Please call a service technician when repeated alarm resets are required to keep the unit operational.

Occupied button (occupied/unoccupied request)

Note: Terminal “U” opens HI to source power on power-up “Occupied”

When the “Occupancy” Button is pushed, the current “Occupied” or “Unoccupied” status of the sensor will be toggled to the opposite condition for 20 seconds. Both the display and “U” terminal output reflect the new status during the 20 seconds. If a confirmation signal is received from the controller into the Status Input terminal “1” within 20 seconds, then the new occupancy condition remains; otherwise the “U” terminal will return to the original state and the “Occupied” Icon will flash the desired occupancy state every 8 seconds.

Up & down setpoint buttons (Temp)

Press the Setpoint “Up/Down” Buttons once to enter the Setpoint Adjustment Mode. The current setpoint value will display for 5 seconds. When the “Up/Down” Buttons are pressed in this mode, the temperature setpoint will change in one degree increments. It will only change within the temperature setpoint range that was ordered (or the setpoint range that was set via the Program Mode).

After 5 seconds of no buttons being pushed, the sensor will go into the standard display mode.

Optional technician adjustments

Note: The sensor setup is factory set per your order. Setup adjustments are not required

The unit is shipped ready to install per the order and does not require any special setup or programming. The following Program Menu Changes are available if the installer decides to change the factory settings. The Setpoint Up/Down Buttons and Occupancy Button are used in the Programming Mode to make Menu changes and selection.

Set-up jumper (J50) configuration

(Factory set per order)

CAUTION

Turn off power to the unit before reconfiguring the F/C or MDL jumpers settings. Damage to the sensor board can occur if jumpers are moved while there is power to the unit and sensor.

Figure 7: J50 Jumper

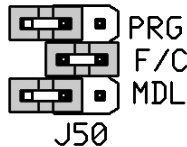

Label description setting

PRG	Program Mode or Run Mode	Program Mode = Jumper installed for Program Mode (See Program Menu below). Run Mode = Jumper removed for Run Mode (Place jumper on one pin only).
F/C	°C Indication or °F Indication	°C = Jumper installed for °C . °F = Jumper removed for °F Indication (Place jumper on one pin only).
MDL	Sets the Model	Jumper not consequential for PN 910152147.

Program mode menu pages:

(Display required)

Note: Both J50 "F/C" and J50 "MDL" jumpers must be configured first before entering the program "PRG" mode.

Entering program mode and making changes

1. Install the J50 "PRG" jumper onto both pins with power turned on to enter Program Mode.
2. Press the Up/Down Buttons to advance to the desired program parameter from P1 through P14 (Parameters described below).
3. Press the Occupancy Button to select the specific program parameter to change.
4. Change the parameter value as described in the Mode Menus section below. (Usually with the Up/Down Button)
5. Press the Occupancy Button again to set the selected parameter.
6. Press the Up/Down Buttons to proceed to the next parameter (as in Step 2 above).
7. When done making changes, remove the J50 "PRG" jumper (and place over one pin). This action will end the Programming Mode and store all the values. The sensor is now in the Run Mode.

Program mode menu pages

- P1 Setpoint Mode** (Factory set to temperature value "S1". J50 °F/°C must be set before entering the program "PRG" mode).
- **S1** – "UP/DOWN" to select setpoint to absolute temperature setpoint value. Actual setpoint value set in P4 and P5. **Example:** 55°F (13° C) to 95°F (35° C).
 - **S2** – "UP/DOWN" to select setpoint to relative temperature setpoint value of ±5.0°F (±2.8°C).
 - **S3** – "UP/DOWN" to select setpoint to relative temperature setpoint value of ±3.0°F (±1.67°C) for Infinity systems.
- P2 Temperature Offset** (Factory set to zero).
- "UP" to increase offset up to +2.
 - "DOWN" to decrease offset down to -2.
- P4 Setpoint Low Range** (Factory set to 55°F or 13°C depending on J50 °F/°C setting).
- P1 in S1 Mode:** Adjustment range 55 to 65°F or 13 to 18°C.
- "UP" to increase the low setpoint range up to 65°F or 18°C.
 - "DOWN" to decrease the low setpoint range down to 55°F or 13°C.
- P1 in S2 Mode:** No adjustment. Factory set to -5°F (-2.8°C).
- P1 in S3 Mode:** No adjustment. Factory set to -3°F (-1.6°C) for Infinity systems.

- P5 Setpoint High Range** (Factory set to 95°F or 35°C depending on J50-°F/°C setting).
- P1 in S1 Mode:** Adjustment range 85 to 95°F or 29 to 35°C.
- “UP” to increase the high setpoint range up to 95°F or 35°C.
 - “DOWN” to decrease the high setpoint range down to 85°F or 29°C.
- P1 in S2 Mode:** No adjustment. Factory set to 5°F (2.8°C).
- P1 in S3 Mode:** No adjustment. Factory set to 3°F (1.6°C) for Enfinity systems.
- P8 Display Resolution** (Factory set to ±0.5 resolution, “0.5”).
- 0.1** “UP/DOWN” to set resolution to ±0.1, (Rounds up at .05).
- 0.5** “UP/DOWN” to set resolution to ±0.5, (Rounds up at .08).
- 1** “UP/DOWN” to set resolution to ±1.0, (Rounds up at .5).
- P10 Display Mode** (Factory set to #4 for WSHP units).
- “UP/DOWN” to set display mode.
 - Choose from numbered list below.
- 1 = No value on the main display (Blank).
- 2 = Temperature Value (TV).
- 3 = Temperature Setpoint (TSP).
- 4 = Temperature Value & Temperature Setpoint (Default)
- P11 Setpoint Button Lockout** (Factory set to “0”: Temp. Setpoint Enabled).
- Note:** 1. Selections in P11 will impact Menu P10.
2. After changing P11 option, remove PRG jumper on J50 to exit programming mode and refresh options. In order to make additional programming changes, PRG Jumper must be reinstalled to enter programming mode.
- 1** Temperature Setpoint is Disabled.

- P13 Occupancy Button Enable/Disable** (Factory set to enabled “ObE”).
- ObE** Occupancy Button Enabled (Factory default)
- Obd** Occupancy Button Disabled

P14 Firmware Version - XXX.X

P15 For Units with a BACnet or LONWORKS Communications Module

Setpoint Calibration Offset (Factory set to “0”.)

- “UP” to increase offset up to +100 will raise the MicroTech III perceived set point from the sensor.
- “DOWN” to decrease offset down to -100. This will lower the MicroTech III perceived set point from the sensor.

Calibrate the displayed set point to the set point value sent to the MicroTech III as follows:

1. Set the digital room sensor displayed set point to 90° F.
2. Observe the local set point via the BAS/EMS connected by the BACnet or LONWORKS Communications Module.
3. Adjust the Configuration Menu P15 on the sensor until the local set point and the displayed set point are equal.

P15 For Units without a BACnet or LONWORKS Communications Module

Setpoint Calibration Offset (Factory set to “0”.)

- “UP” to increase offset up to +100 will raise the MicroTech III perceived set point from the sensor.
- “DOWN” to decrease offset down to -100. This will lower the MicroTech III perceived set point from the sensor.

The Setpoint Calibration Offset can be calculated using the following formula:

$$\text{ROUND} [(\text{Controller Vdd} / \text{Sensor Vdd}) * 1000] - 1000$$

Example:

Given: Controller Vdd = 5.15VDC

Sensor Vdd = 4.95 VDC

The programmed Calibration Offset would be
 $[(5.15/4.95)*1000] - 1000 = 40$

Problem & possible solution

No display

- Check the power connections and power voltage level
- Replace unit if power is okay.

No temperature signal

- Be sure the termination and wiring is correct and the controller is set up properly. Make sure the "Override/Reset" button is not stuck down.
- Replace unit if all checks are okay.

Override/Reset not working

- Measure the resistance to ground at the sensor output terminal (Term. 4). When pushing the Override Button, it should show a short. If not, replace the sensor.

Occupied not working

- Verify that this terminal is in a powered circuit. Measure the voltage to ground at the occupied terminal (U). When pushing the Occupied Button (<2 secs), it should read close to 0 volts. When you lift the button it should read high volts.
- Replace unit if it still doesn't work.

"Err" shown on the screen

- This indicates that the temperature and humidity sensing element has failed.

Up or Down key does not change setpoints

- Check to verify Set points are not locked out in Programming Mode Menu Page P11.

Solid Man goes away after 20 seconds

- Occupancy Request was not acknowledged by Main controller, check wiring of Status Signal from controller.

Supply voltage

AC Hot..... (R) 7 to 28VAC, 24VAC nominal, 0.17VA
 GND/Neutral..... (5) Sensor common reference ground.

Sensor

Temperature 10K-2 Thermistor, $\pm 0.36^{\circ}\text{F}$ ($\pm 0.2^{\circ}\text{C}$)

Outputs

Unoccupied..... (U), Unoccupied = Digital low to ground
 (Same ground as power source), 100mA @5VDC max.
 System Off..... (E), System Off = Digital low to ground
 (Same ground as power source), 100mA @5VDC max.
 Setpoint (3), Analog, 0 to 5 VDC.
 Temperature (4), Analog thermistor resistance.

Sensor controls

Setpoint 2 Up/Down buttons
 Occupied 1 button to check and request change in
 Occupancy Status.
 Override/Reset 1 button to request timed occupancy
 override and reset alarms.
 Inputs:..... (1), Controller alarm & system status,
 5VDC max.
 Termination: 10 Terminals, 16 to 22 AWG.
 Mounting:..... Standard 2" x 4" J-Box or Drywall

Field setup jumper J50

PRG Program Mode, On = Program, Off = Run.
 F/C..... Display Units, On = $^{\circ}\text{C}$, Off = $^{\circ}\text{F}$.
 MDL MODEL, On = WSHP.

Display

LCD
 Overall size..... 2.04"W x 1.33"H.
 Main Digits..... ± 999.9 Digits @0.6"H
 Resolution..... 0.5 displayed value, 0.1 for offset adjust
 Main Value..... Temp, Humidity & Setpoint, toggling every
 5 sec.
 Eng. Units..... $^{\circ}\text{F}$, $^{\circ}\text{C}$, %RH.
 Occupied Icon..... Hollow = Unoccupied, Solid = Occupied.
 Function..... Override, Alarm, E-Save, Setpoint

Field configuration menu

(Requires J50 PRG jumper to be "On")

Offset..... Temp display, $\pm 2^{\circ}\text{F}$ ($\pm 1.0^{\circ}\text{C}$).
 Setpoint range Default 55 $^{\circ}$ to 95 $^{\circ}\text{F}$ (13 $^{\circ}$ to 35 $^{\circ}\text{C}$), $\pm 3^{\circ}\text{F}$
 ($\pm 1.6^{\circ}\text{C}$) or $\pm 5^{\circ}\text{F}$ ($\pm 3^{\circ}\text{C}$). Adjustable
 between 55 $^{\circ}$ to 95 $^{\circ}\text{F}$, $\pm 3^{\circ}\text{F}$ ($\pm 1.6^{\circ}\text{C}$) or
 $\pm 5.0^{\circ}\text{F}$ ($\pm 2.8^{\circ}\text{C}$).
 Resolution..... Main display can be default .5, or .1 or 1.0
 ($^{\circ}\text{F}$, $^{\circ}\text{C}$).
 Display Mode..... Temp only, Setpoint only or both.

Enclosure material

ABS Plastic, UL94V-0.

Ambient

32 $^{\circ}$ to 122 $^{\circ}\text{F}$ (0 $^{\circ}$ to 50 $^{\circ}\text{C}$), 0 to 95%RH, Non-condensing.

Agency

Restriction of the use of certain Hazardous Substances
 (RoHS).



Daikin Applied Training and Development

Now that you have made an investment in modern, efficient Daikin equipment, its care should be a high priority. For training information on all Daikin HVAC products, please visit us at www.DaikinApplied.com and click on Training, or call 540-248-9646 and ask for the Training Department.

Warranty

All Daikin equipment is sold pursuant to its standard terms and conditions of sale, including Limited Product Warranty. Consult your local Daikin Applied representative for warranty details. Refer to Form 933-430285Y. To find your local Daikin Applied representative, go to www.DaikinApplied.com.

Aftermarket Services

To find your local parts office, visit www.DaikinApplied.com or call 800-37PARTS (800-377-2787).
To find your local service office, visit www.DaikinApplied.com or call 800-432-1342.

This document contains the most current product information as of this printing. For the most up-to-date product information, please go to www.DaikinApplied.com.

Products manufactured in an ISO Certified Facility.